

INSTRUMENTS FOR SPECIAL REQUIREMENTS

Calibration Baths

Beer Forcing Test Bath

Visco Baths

Immersion Coolers

Flow-through Coolers

Fluid-Gas Heat Exchanger

Temperature Controllers

Refrigerators for Chemicals

Wireless Communication & Software



Wide Range of Applications for the Right Temperature



Calibration Baths

-30 °C ... +300 °C

- Calibration of sensors, measuring instruments, thermometers, etc.
- Highest temperature stability up to ± 0.005 °C
- With calibration certificates according to ISO and DKD (option)



Beer Forcing Test Bath

-38 °C ... +80 °C

- To determine of 'best before' date of beer
- Preset temperature profiles for forcing tests



Visco Baths

+20 °C ... +150 °C

- For highly precise measuring applications with viscometers and densimeters
- Transparent bath tanks (Plexiglass®, stainless steel design, or glass with insulated windows)



Wireless Communication

- Remote control, monitoring, visualization and documentation
- All JULABO units with RS232 interface
- Control via PC or Tablet PC



Fluid-Gas Heat Exchanger

-95 °C ... +210 °C

- Heat exchanger for fluid-based gas temperature control.
- Wide temperature ranges, high temperature stability, high stability against environmental effects



Immersion and Flow-through Coolers

-90 °C ... +30 °C

- Rapid cooling, a perfect complement to heating circulators
- Environmentally friendly alternative to tap water cooling and dry ice



Temperature Controllers

-100 °C ... +400 °C

- Measurement, control and monitoring of any electrically heated equipment in laboratories and pilot plants



Refrigerators for Chemicals

-2 °C ... +12 °C

- Storing and cooling of hazardous substances
- Spark free interior with self-protecting control electronics

Instruments for Special Requirements

Calibration Baths.....	4-5	Refrigerators for Chemicals.....	12
Beer Forcing Test Bath	6	Wireless Communication & Software	13-16
Visco Baths	7	Accessories	17-19
Immersion Coolers	8-9	JULABO Advantages.....	20-21
Flow-through Cooler	10	Technical Specifications	22-24
Fluid-Gas Heat Exchanger.....	10	Mains Voltages.....	25
Temperature Controllers	11		

Calibration Baths

Calibration Baths

for working temperatures from +50 °C to +300 °C

JULABO calibration baths are ideal for high precision calibration of sensors, measuring instruments, thermometers, etc.

The instruments are certified for application in DKD laboratories and according to the requirements specified by DIN EN ISO 9001:2000.

Advantages

- Highest temperature stability up to ± 0.005 °C
- Precision Pt100 sensor for reference temperature measurements (optional)
- Display resolution 0.01 °C across the entire temperature range
- Temperature chamber with constant level for best uniformity
- With calibration certificates according to ISO and DKD (option)

VFD Comfort Display



All temperatures on one screen:
The large display shows up to three temperature values simultaneously:

- ① Reference temperature
- ② Setpoint temperature
- ③ Actual temperature

Temperature chamber with uniform overflow

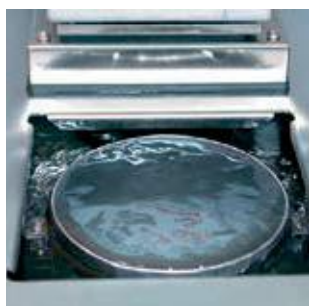

Removable circulator



SL-8K

Order No. 9 352 508

Model SL-8K

Working temperature range °C +50 ... +300

Temperature stability °C ± 0.005

Heating capacity kW 3

Pump capacity l/min 22 ... 26

Flow rate/Pressure bar 0.4 ... 0.7

Bath opening / Usable bath depth cm \varnothing 12 / 17

Filling volume liters 8

Dimensions cm W x L x H 22 x 46 x 47



SL-14K

Order No. 9 352 514

Model SL-14K

Working temperature range °C +50 ... +300

Temperature stability °C ± 0.005

Heating capacity kW 3

Pump capacity l/min 22 ... 26

Flow rate/Pressure bar 0.4 ... 0.7

Bath opening / Usable bath depth cm \varnothing 12 / 31

Filling volume liters 14

Dimensions cm W x L x H 22 x 46 x 61

Calibration Baths

for working temperatures from -30 °C to +200 °C
with integrated refrigeration unit

The calibration baths on this page feature an integrated refrigeration unit and are suitable for calibration applications to -30 °C. The bath cover with openings and Viton® sleeves is already included in delivery for all models.

Advantages

- Integrated refrigeration unit
- Compact design
- Low noise level
- ACC Active Cooling Control across the entire working temperature range
- Removable venting grid
- With calibration certificates according to ISO and DKD (option)

Applications

Calibration for the determination of conformity to national and international standards such as temperature sensors, measuring units or thermometers.



FK30-SL

Order No.	9 352 627		
Model	FK30-SL		
Working temperature range °C	-30 ... +200		
Temperature stability °C	±0.005		
Heating capacity kW	2		
Cooling capacity kW (Bath fluid: Ethanol)	+20 °C	0 °C	-20 °C
	0.46	0.34	0.15
Pump capacity	l/min	22 ... 26	
Flow rate/Pressure	bar	0.4 ... 0.7	
Bath opening/Usable bath depth cm	Ø 12 / 17		
Filling volume liters	14		
Dimensions cm	W x L x H 32 x 45 x 79		



FK31-SL

Order No.	9 352 628		
Model	FK31-SL		
Working temperature range °C	-30 ... +200		
Temperature stability °C	±0.005		
Heating capacity kW	2		
Cooling capacity kW (Bath fluid: Ethanol)	+20 °C	0 °C	-20 °C
	0.46	0.34	0.15
Pump capacity	l/min	22 ... 26	
Flow rate/Pressure	bar	0.4 ... 0.7	
Bath opening/Usable bath depth cm	Ø 12 / 31		
Filling volume liters	24		
Dimensions cm	W x L x H 32 x 45 x 91		

Beer Forcing Test Bath

Beer Forcing Test Bath

to determine the 'best before' date of beer

The JULABO Beer Forcing Test Bath in conjunction with a photometer determines the product life of beer before clouding. The simulated aging process is achieved through a programmable temperature profile, which is repeated, until the first clouding develops.

- Automatic cycles of temperature ramps simulate aging
- Pre-programmed temperature profiles for forcing test
- Program modification possible at any time
- Integrated meter for reproducible time sequence
- Large bath opening with insert for 20 bottles, 0.5 liters each (Racks for other bottle sizes on request)
- Removable Plexiglass® cover

Applications

Forcing tests, determination of 'best before' date by simulating the beer aging process.



F38-ME

Order No.	9 162 638		
Model	F38-ME		
Working temperature range °C	-38 ... +80		
Temperature stability °C	±0.05		
Heating capacity kW	2		
Cooling capacity kW	+20 °C	0 °C	-20 °C
	0.92	0.66	0.32
Pump capacity	l/min	11 ... 16	
Flow rate / Pressure	bar	0.23 ... 0.45	
Bath opening / Bath depth cm	W × L / D	35 x 41 / 27	
Filling volume liters	45		
Dimensions cm	W × L × H	46 x 70 x 89	

Forcing test

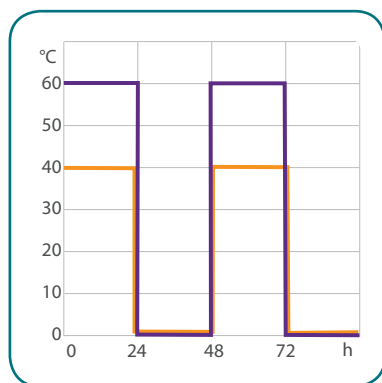

Practical. Preset temperature profiles!

All program steps for the forcing test are preset

Visco Baths



ME-16G

Order No.	9 162 616	
Model	ME-16G	
Working temperature range °C	+20 ... +100	
Temperature stability °C	±0.01	
Heating capacity kW	2	
Cooling coil	integrated	
Pump capacity l/min	11 ...	16
Flow rate/Pressure bar	0.23 ...	0.45
Bath opening/Number/Bath depth	7.6 x 7.6 / 2x / 31	
Number of viscometers	2	
Filling volume liters	16	
Dimensions W x L x H cm	Ø 29 x 48	



ME-18V

Order No.	9 162 518	
Model	ME-18V	
Working temperature range °C	+20 ... +150	
Temperature stability °C	±0.01	
Heating capacity kW	2	
Cooling coil	integrated	
Pump capacity l/min	11 ...	16
Flow rate/Pressure bar	0.23 ...	0.45
Bath opening/Number/Bath depth	9 x 9 / 2x / 37	
Number of viscometers	2	
Filling volume liters	18	
Dimensions W x L x H cm	36 x 24 x 54	



ME-31A

Order No.	9 162 331	
Model	ME-31A	
Working temperature range °C	+20 ... +60	
Temperature stability °C	±0.01	
Heating capacity kW	2	
Cooling coil	integrated	
Pump capacity l/min	11 ...	16
Flow rate/Pressure bar	0.23 ...	0.45
Bath opening/Number/Bath depth	9 x 9 / 3x / 37	
Number of viscometers	3	
Filling volume liters	31	
Dimensions W x L x H cm	50 x 20 x 56	

Visco Baths

for highly precise temperature applications in the bath tank

JULABO visco baths for highly precise temperature control of viscometers, densimeters and similar products.

For the ME-31A, the equipment includes a Plexiglass® bath tank, for the ME-16G a glass tank, and for the ME-18V, a stainless steel bath tank with insulated outer housing and 185 x 245 mm high-quality multiple-layer insulated glass windows.

Advantages

- Temperature setting and display resolution 0.01 °C
- Temperature stability ±0.01 °C
- Programmer with real time clock
- Cooling coil for applications below ambient temperature

Applications

For measurements with capillary viscometers or use of densimeters and similar products. ME-18V enables operation conforming to ASTM D445.

Custom model ME-18V-TT

with special cooling coil for applications to -40 °C available! Just ask!

Heat-up time

Bath fluid: water

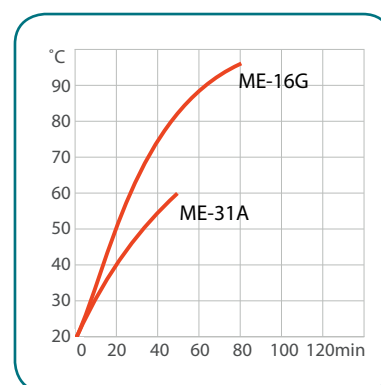

Heat-up time

Bath fluid: Thermal H

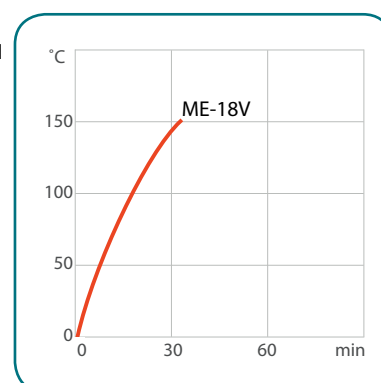

Immersion Coolers

Immersion Coolers

with immersion probe for rapid cooling of fluids

JULABO immersion coolers are ideal for counter-cooling in combination with heating circulators and for rapid cooling of fluids down to low temperatures. These units represent a budget-priced alternative to customary cooling with tap water and as a substitute for dry ice.

- User-friendly operation and handling
- Compact design, small footprint
- FT402, FT902 and FT903 with integrated temperature control and display as well as external Pt100 sensor (200 × 6 mm Ø, stainless steel)
- Environmentally friendly alternative to precious tap water
- Dry ice substitution



FT200

Order No.	9 650 820		
Model	FT200		
Working temperature range °C	-20 ... +30		
Temperature stability °C	-		
Display resolution	-		
Cooling capacity kW	+20 °C	+10 °C	0 °C
	0.25	0.2	0.15
	-20 °C	-40 °C	-80 °C
	0.04	-	-
Immersion probe / flexible probe (L x dia. cm)	9 x 4		
Connection tube (L) cm	120		
Dimensions cm	W x L x H 18 x 27 x 39		



FT400

Order No.	9 650 840		
Model	FT400		
Working temperature range °C	-40 ... +30		
Temperature stability °C	-		
Display resolution	-		
Cooling capacity kW	+20 °C	+10 °C	0 °C
	0.45	0.36	0.30
	-20 °C	-40 °C	-80 °C
	0.14	0.03	-
Immersion probe / flexible probe (L x dia. cm)	12 x 5		
Connection tube (L) cm	120		
Dimensions cm	W x L x H 20 x 30 x 43		



FT900

Order No.	9 650 890		
Model	FT900		
Working temperature range °C	-90 ... +30		
Temperature stability °C	-		
Display resolution	-		
Cooling capacity kW	+20 °C	+10 °C	0 °C
	0.3	0.27	0.27
	-20 °C	-40 °C	-80 °C
	0.24	0.2	0.07
Immersion probe / flexible probe (L x dia. cm)	65 x 1.5 flexible		
Connection tube (L) cm	160		
Dimensions cm	W x L x H 38 x 55 x 60		

Applications

Cooling of liquids, dry-ice substitute, countercooling for heating circulators, saving of tap water



FT402

Order No.	9 650 842		
Model	FT402		
Working temperature range °C	-40 ... +30		
Temperature stability °C	±0.5		
Display resolution	LED / 0.1		
Cooling capacity kW	+20 °C	+10 °C	0 °C
	0.45	0.36	0.30
	-20 °C	-40 °C	-80 °C
	0.14	0.03	-
Immersion probe / flexible probe (L x dia. cm)	12 x 5		
Connection tube (L) cm	120		
Dimensions cm	W x L x H 20 x 30 x 43		



FT902

Order No.	9 650 892		
Model	FT902		
Working temperature range °C	-90 ... +30		
Temperature stability °C	±1		
Display resolution	LED / 0.1		
Cooling capacity kW	+20 °C	+10 °C	0 °C
	0.3	0.27	0.27
	-20 °C	-40 °C	-80 °C
	0.24	0.2	0.07
Immersion probe / flexible probe (L x dia. cm)	65 x 1.5 flexible		
Connection tube (L) cm	160		
Dimensions cm	W x L x H 38 x 55 x 60		



FT903

Order No.	9 650 893		
Model	FT903		
Working temperature range °C	-90 ... +30		
Temperature stability °C	±1		
Display resolution	LED / 0.1		
Cooling capacity kW	+20 °C	+10 °C	0 °C
	0.3	0.29	0.28
	-20 °C	-40 °C	-80 °C
	0.25	0.23	0.05
Immersion probe / flexible probe (L x dia. cm)	5.6 x 14		
Connection tube (L) cm	160		
Dimensions cm	W x L x H 38 x 55 x 60		

Flow-through Cooler / Fluid-Gas Heat Exchanger

Flow-through Cooler

for cooling of loop circuits

The JULABO flow-through cooler is designed for applications below ambient temperature. The cooler is connected with tubing into the loop circuit, e.g. in the return line of a circulator. In combination with a heating circulator, almost every application can be equipped with cooling capability.

- Allows applications below ambient temperature with heating circulators and circulating pump
- Liquid flow through tubing into the cooler
- Environmentally friendly by saving precious tap water

Applications

For applications with heating circulators below the ambient temperature, integration into loop circuits



FD200

Order No.	9 655 825	
Model	FD200	
Working temperature range °C	+10 ... +30	
Cooling capacity kW	+20 °C 0.22	+10 °C 0.18
Dimensions cm	W x L x H 18 x 27 x 39	

Included in delivery: two barbed fittings each for tubing 8 and 12 mm ID



Fluid-Gas Heat Exchanger

Order No.	8 810 100	
Model	Fluid-Gas Heat Exchanger	
Working temperature range °C	-95 ... +210	
Gas OUT	-90 ... +200	
Gas IN	-40 ... +60	
Suitable fluids	JULABO Thermal, water, ethanol, water-glycol, silicon oil	
Viscosity max. cSt	30	
Housing material	Stainless steel	
Gas flow rate	l/min	0 ... 100
Pressure stability	bar	6
Gas connectors	In: 1/4" NPT quick connector Out: 1/4" NPT female	
Fluid connectors	M16 x 1 male	
Attachment	Flange with holes dia. = 6 mm	
Weight kg	1.3	
Dimensions cm	W x L x H 25.5 x 7 x 7.2	

Fluid-Gas Heat Exchanger

The stainless steel design of the Fluid-Gas Heat Exchanger provides excellent resistivity against chemical effects. The specially developed insulation and the extraordinary design of the Fluid-Gas Heat Exchanger provide high efficiency at small overall dimensions.

The solution

The new JULABO Fluid-Gas Heat Exchanger merges the advantages of fluid based temperature control and your gas process requirements. Wide temperature ranges, high temperature stability, high stability against environmental effects.

Requirement of gas properties

nonflammable, non condensing, non corrosive

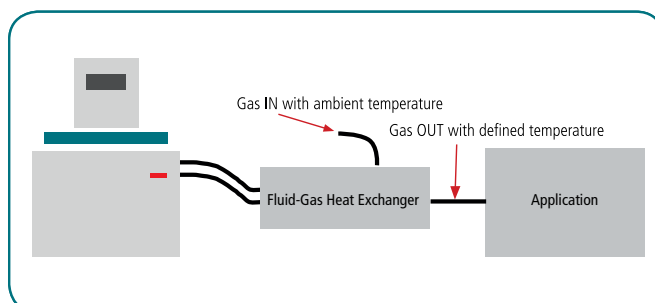

Temperature Controllers

Temperature Controllers

for measuring, control and monitoring

JULABO temperature controllers are used in all temperature-dependent measuring, control, safety, and monitoring applications in laboratories and pilot plants.

LC4, LC6

- Multi-Display (LED) with splash-proof keypad
- Warning and cut-off protection for high/low temperature
- RS232 interface

LC6 additional features

- 2 working sensors for different measurement locations (cascade-controller)
- Stakei connection for tap water cooling via solenoid valve
- Integrated programmer for 6 × 60 program steps

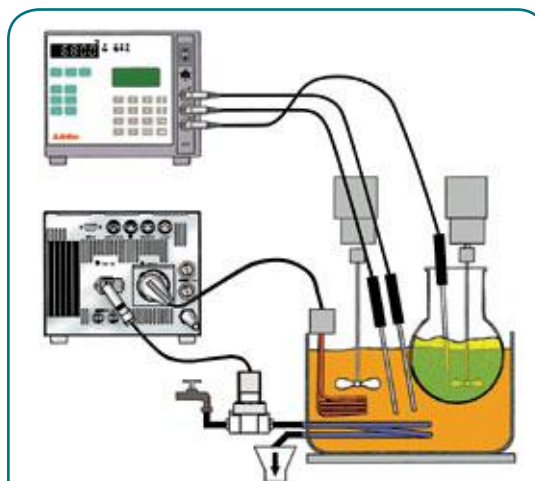

Practical tip

The consumer (e.g. heater) is connected via power socket (Schuko) at the back of the instrument. Separate sensors for working and safety temperatures control the application. Analog and digital interfaces are available for other applications.

Applications

For precise and reliable temperature control for heating mantles and heating collars, oil baths in combination with distillation/pilot plants, for controlling an indirect cooling water flow with solenoid valve.



LC4

Order No.	9 700 140
Model	LC4
Working temperature range °C	-50 ... +350
Temperature stability in ext. system °C	± 0.05
LED display / resolution °C	2 / 0.1
LCD display / resolution °C	-
Working sensor	1 Pt100
Safety sensor	1 Pt100
Maximum connection wattage kW	2
Dimensions cm	W × L × H 17 × 17 × 16



LC6

Order No.	9 700 160
Model	LC6
Working temperature range °C	-100 ... +400
Temperature stability in ext. system °C	< ±0.03
LED display / resolution °C	1 / 0.01
LCD display / resolution °C	1 / 0.01
Working sensor	2 Pt100
Safety sensor	1 Pt100
Maximum connection wattage kW	3
Dimensions cm	W × L × H 21 × 18 × 18

A large selection of accessories at www.julabo.com

Refrigerators for Chemicals

Refrigerators for Chemicals

for storing and cooling of chemicals and hazardous substances

JULABO refrigerators for chemicals are designed for storing and cooling hazardous substances. The spark free interior prevents damage caused by spilled or evaporating chemicals.

- Spark free interior
- Storing and cooling of hazardous substances
- Self-protecting control circuit
- Digital temperature display (LED)
- Overload protection for cooling compressor with test button
- Cut-off in case of disturbance with optical alarm signal
- Working and safety sensors are protected against short circuits and interruption
- Potential-free switch contact for disturbance relaying



KRC50

Order No. 8 800 705

Model KRC50

Working temperature range °C -2 ... +12

Temperature selection / display Analog / LED

Temperature stability °C ±1

Volumetric capacity liters 68

Inner dimensions W x L x H cm 42 x 29 x 44

Outer dimensions W x L x H cm 55 x 64 x 63



KRC180

Order No. 8 800 718

Model KRC180

Working temperature range °C -2 ... +12

Temperature selection / display Analog / LED

Temperature stability °C ±1

Volumetric capacity liters 180

Inner dimensions W x L x H cm 52 x 40 x 70

Outer dimensions W x L x H cm 60 x 64 x 86

WirelessTEMP

Networking and Remote Control with WirelessTEMP by JULABO

Remote control, monitoring, visualization and documentation: JULABO networking solutions and EasyTEMP simplify and automate your workflows. JULABO temperature control units are comfortably controlled and monitored via PC or Tablet PC. Measurement values are easily recorded, documented and visualized on any PC or Notebook. Laboratory instruments are easily connected via interfaces (RS232, RS485), Ethernet or wirelessly.

Strong benefits for more organization

- Increased efficiency by automated workflow
- Comfortable instrument control directly from your workstation
- Instrument control via PC or Tablet PC
- Numerous possibilities to visualize and record measurement data
- Time savings as less inspection rounds
- Economic solution for small and medium laboratories
- Easy to start and operate
- Functions with almost all JULABO units with RS232 interface
- Support of industrial standards like RS485 and Ethernet

WirelessTEMP®

We gladly support you in the planning of the connection of your JULABO unit.
Call +49 (0) 7823 51-190

WirelessTEMP applications

To find the right WirelessTEMP application solution for your requirements, answer the following questions while planning your application.

Question 1

How many JULABO units will be networked?

(max. 1/max. 2/max. 4/max. 8)

Question 2

Which type of interface do my JULABO units feature?

(RS232/Ethernet)

Question 3

How is the connection set up?

(via WLAN / partially via WLAN / via LAN)

Question 4

Do I require an ATEX solution?

(Yes/No)



8 980 036



8 980 031



8 980 034



8 980 035



8 980 032



8 980 033



WirelessTEMP accessories

Order No.	Description	Suitable for
8 900 020	Profibus DP interface	All models with RS232 interface
8 900 024	RS485 interface	All models with RS232 interface
8 900 110	USB interface adapter cable, 2.5 m	All models with RS232 interface
8 980 031	Ethernet/RS232 interface converter	All models with RS232 interface
8 980 071	RJ45 cable, 5 m	Interface converter
8 980 032	4-EtherNet/RS232 converter	All models with RS232 interface
8 980 033	8-EtherNet/RS232 converter	All models with RS232 interface
8 980 034	WLAN/RS232 converter	All models with RS232 interface
8 980 035	2 Channel WLAN/RS232 converter	All models with RS232 interface
8 980 036	ATEX Tablet Agile X	All models with RS232 interface
8 980 073	RS232 interface cable, 2.5 m	All models with RS232 interface
8 980 074	RS232 interface cable, 5 m	All models with RS232 interface

WirelessTEMP application solutions (exemplary)

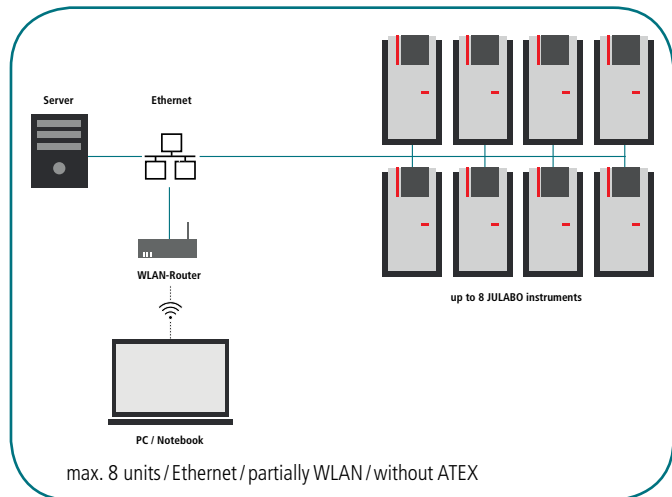
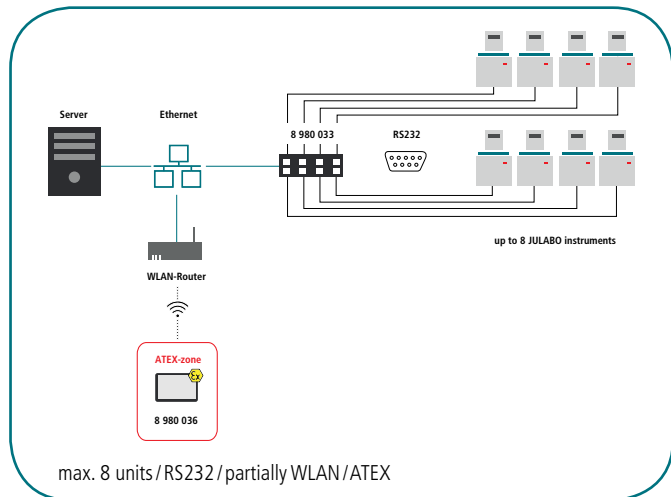
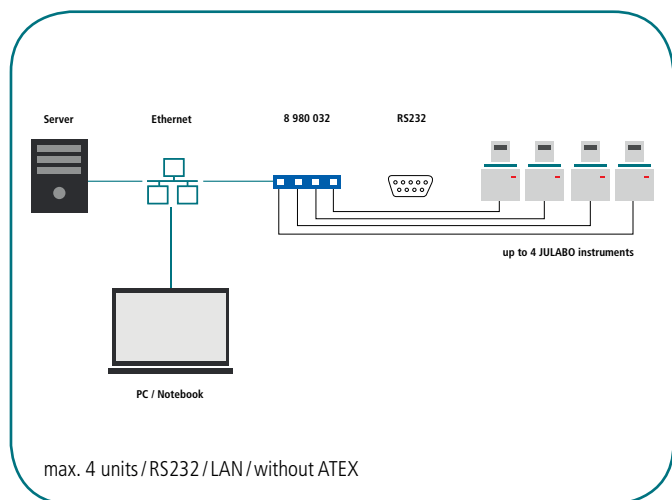
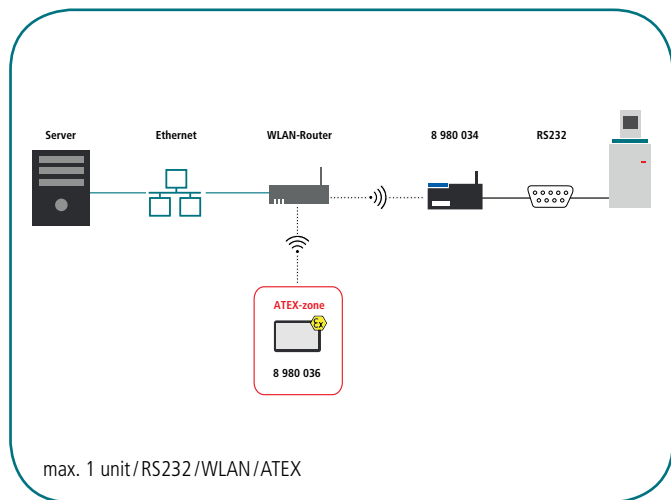

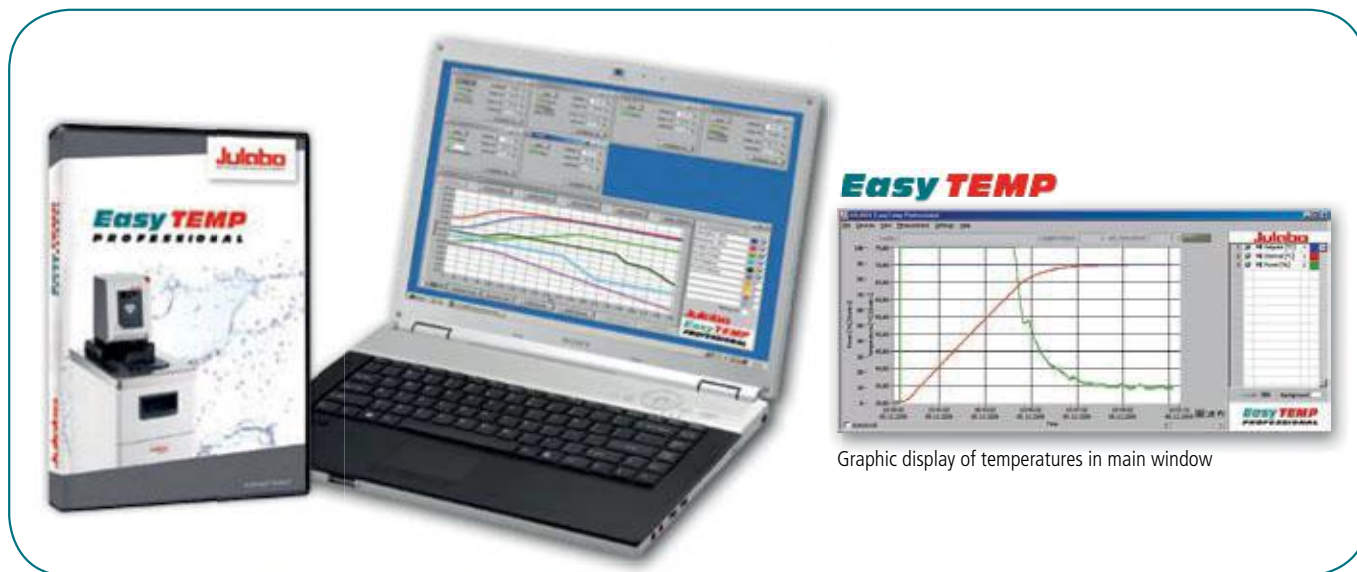

Graphic display of temperatures in main window

EasyTEMP Professional Software

PC-software to control, visualize and record

EasyTEMP Software allows control and monitoring of JULABO temperature control units using a Windows® based PC. EasyTEMP features a variety of functions to visualize and document temperature- and time-dependent processes.

- Connect WirelessTEMP via RS232, USB or wirelessly
- Diagram function for graphic display of measurement values
- Storage of measurement values for processing, e.g. in Microsoft® Excel®
- Temperature profile programming with one second accuracy
- Display in degrees Celsius (°C) or Fahrenheit (°F)
- EasyTEMP basic version: free of charge download
- EasyTEMP Professional version with many additional functions

Easy set-up of laboratory units

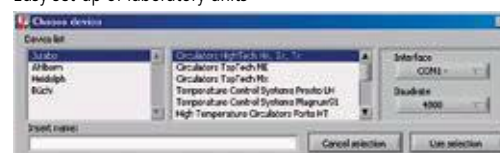

Each laboratory device has its own control window



Wireless communication & Software

Description	Suitable for
8 901 102 EasyTEMP software (free of charge at www.julabo.com)	All models with RS232 interface & USB
8 901 105 EasyTEMP Professional software, incl. USB dongle	All models with RS232 interface & USB

EasyTEMP Version Comparison

PC-software to control, visualize and record

Control, visualize and document temperature and time-dependent processes using JULABO software. Free of charge EasyTEMP is perfect for simple control applications with one JULABO unit (download at www.julabo.com).

EasyTEMP Professional is available for more complex applications with up to 24 units. The software installs easily and offers instrument control via RS232 interface, USB converter or WirelessTEMP accessories.

Download the basic EasyTEMP software free of charge at www.julabo.com

Function overview and comparison of JULABO EasyTEMP and JULABO EasyTEMP Professional	EasyTEMP	EasyTEMP Professional
Control of one JULABO instrument with integrated interface	•	•
Control of up to 24 JULABO units with integrated interface		•
Support of industrial standards like RS485 and Profibus		•
Instrument window:		
Recording and display of currently measured values on PC	•	•
Setpoint input via PC	•	•
Status display	•	•
Individual control window for each unit		•
Simultaneous start of units with just one button		•
Recording of measured values:		
Zoom function for freely scalable graphic	•	•
Displays up to 4 curves in one diagram	•	
Displays unlimited number of curves in one diagram		•
Curves can be assigned to individual scales		•
Input of formulas such as averaging, differences between measured values, etc.		•
Input of text comments with display in the diagram		•
Ramp programming:		
Ramp function with up to 100 steps	•	
Ramp function with up to 1000 steps (individually for each instrument)		•
Cyclic repetition of programmed profiles	•	•
Modify running profiles	•	•
Graphic display of overall profiles		•
Data recording:		
Records measured values in ASCII format	•	•
Records measured values in Microsoft® Excel®		•
Saves additional, relevant measuring data		•
Freely adjustable monitoring pattern		•
Export function of graphic into JPG format		•
Loads previously created recordings with print function		•
Integration of laboratory instruments of different makes e.g. stirrers, balances, dosing pumps, pH measuring instruments, etc.		on request



Viton® sleeves

Order No.	Description	Suitable for
8 930 602	Viton® sleeves for sensor 2 mm Ø	Calibration baths
8 930 603	Viton® sleeves for sensor 3 mm Ø	Calibration baths
8 930 604	Viton® sleeves for sensor 4 mm Ø	Calibration baths
8 930 605	Viton® sleeves for sensor 5 mm Ø	Calibration baths
8 930 606	Viton® sleeves for sensor 6 mm Ø	Calibration baths
8 930 608	Viton® sleeves for sensor 8 mm Ø	Calibration baths



Bath covers and covers

Order No.	Description	Suitable for
8 970 246	Bath cover with openings and Viton® sleeves: 2 × 3 mm, 2 × 4 mm, 2 × 6 mm inner Ø	SL-8K, SL-14K, FK30-SL, FK31-SL
8 970 294	Cover for ME-18V, 4 round openings, Ø 51 mm	ME-18V
8 970 295	Cover for ME-31A, 5 round openings, Ø 51 mm	ME-31A



External Pt100 sensors and clamps

Order No.	Description	Suitable for
8 981 002	Pt100 precision reference sensor, 180 × 4 mm Ø	SL-8K, SL-14K, FK30-SL, FK31-SL
8 981 010	Pt100 sensor, 300 × 6 mm Ø, stainless steel, 1.5 m connecting cable	FT402, FT902, FT903
8 981 017	Pt100 sensor, 200 × 6 mm Ø, stainless steel/PTFE coated, 3 m connecting cable	FT402, FT902, FT903
8 970 400	Clamp for immersion probe for open bath tanks	FT200, FT400, FT402



CR® tubing

Order No.	Description	Suitable for
8 930 008	1 m CR® tubing, 8 mm ID (-30 °C ... +120 °C)	FD200
8 930 012	1 m CR® tubing, 12 mm ID (-30 °C ... +120 °C)	FD200



Viton® tubing

Order No.	Description	Suitable for
8 930 108	1 m Viton® tubing, 8 mm ID (-35 °C ... +200 °C)	FD200
8 930 112	1 m Viton® tubing, 12 mm ID (-35...+200 °C)	FD200

Accessories



Silicon tubing

Order No.	Description	Suitable for
8 930 120	1 m silicon tubing, 10 mm ID (-50 °C ... +180°C)	FD200
8 930 122	1 m silicon tubing, 12 mm ID (-60...+180 °C) Not to be used with silicon bath fluid	FD200



PTFE tubing

Order No.	Description	Suitable for
8 930 140	1 m PTFE tubing, 8 mm ID (-60 °C ... +180 °C)	FD200
8 930 142	1 m PTFE tubing, 12 mm ID (-60 °C ... +180 °C)	FD200



Insulations

Order No.	Description	Suitable for
8 930 410	1 m insulation, 14 mm ID	CR® tubing 8 to 10 mm ID
8 930 412	1 m insulation, 18 mm ID	CR® tubing 12 mm ID, reinforced tubing 8 mm ID



Certificates

Order No.	Description	Suitable for
8 902 901	1-point manufacturer's calibration certificate*	SL-8K, SL-14K, FK30-SL, FK31-SL, ME-16G, ME-18V, ME-31A, F38-ME, FT402, FT902, FT903
8 902 903	3-point manufacturer's calibration certificate*	SL-8K, SL-14K, FK30-SL, FK31-SL, ME-16G, ME-18V, ME-31A, F38-ME, FT402, FT902, FT903
8 902 905	5-point manufacturer's calibration certificate*	SL-8K, SL-14K, FK30-SL, FK31-SL, ME-16G, ME-18V, ME-31A, F38-ME, FT402, FT902, FT903
8 903 015	Manufacturer's testing certificate	SL-8K, SL-14K, LC4, LC6, ME-16G, ME-18V, ME-31A
8 903 025	Manufacturer's testing certificate	FK30-SL, FK31-SL, F38-ME, FD200, FT200, FT400, FT402, FT900, FT902, FT903, KRC50, KRC180
8 902 113	ISO 3-point calibration certificate*	SL-8K, SL-14K, FK30-SL, FK31-SL
8 902 115	ISO 5-point calibration certificate*	SL-8K, SL-14K, FK30-SL, FK31-SL
8 902 123	DKD 3-point calibration certificate*	SL-8K, SL-14K, FK30-SL, FK31-SL
8 902 125	DKD 5-point calibration certificate*	SL-8K, SL-14K, FK30-SL, FK31-SL
8 902 213	ISO 3-point calibration certificate*	Precision reference sensor
8 902 215	ISO 5-point calibration certificate*	Precision reference sensor
8 902 223	DKD 3-point calibration certificate*	Precision reference sensor
8 902 225	DKD 5-point calibration certificate*	Precision reference sensor

* Depending on the certificate, calibration is carried on at 3 or 5 freely selectable measurement points.



IQ/OQ Documentation for equipment qualification

Order No.	Description	Suitable for
2 310 110	IQ/OQ Documentation, Category 1	LC4, LC6, ME-16G, ME-18V, ME-31A, KRC50, KRC180, FD200, FT200, FT400, FT402
2 310 120	IQ/OQ Documentation, Category 2	SL-8K, SL-14K, FK30-SL, FK31-SL, F38-ME, FT900, T902, FT903



Preventative Maintenance contracts

Order No.	Description	Suitable for
2 350 100	Preventative Maintenance Contract Standard includes the following services: Visual inspection, technical diagnostics, read-out of error memory (BlackBox), testing of tube connections and bath fluid, thorough cleaning of performance-reducing contaminations, testing of control behavior (temperature stability), sensor calibration as needed, testing/measuring of pump and cooling capacity (depending on model) and firmware update (if no hardware adjustment is required)	JULABO range of units
2 350 110	Preventative Maintenance Contract Premium includes all services listed above as well as spare parts and labor required for installation or replacement	JULABO range of units

JULABO preventative maintenance contracts comprise the yearly maintenance of the units named in the contract. Availability is model- and country-dependent.

The **JULABO** advantages at a glance.

JULABO temperature control – high-precision and speed

JULABO products include high-quality temperature control solutions to cover the temperature range from -95 °C to +400 °C.



Refrigerated Circulators

The JULABO refrigerated circulators are suitable for internal and external applications and can be used within the temperature range of -95 °C to +200 °C.

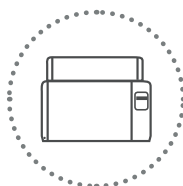

Water Baths and Shaking Water Baths

Water baths and shaking water baths from JULABO can be used for a variety of applications in the temperature range from +18 °C to +99.9 °C.

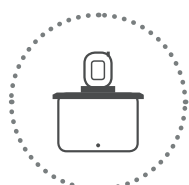

Heating Circulators

Heating circulators are available in various designs including Heating Immersion Circulators, Open Heating Bath Circulators, or Heating Circulators and cover the temperature range from +20 °C to +300 °C.



Additional Products

In addition, the JULABO product portfolio has equipment for special applications such as Calibration Baths, Visco Baths, Beer Forcing Test Bath, Immersion/Flow-Through Coolers, Temperature Controllers and Refrigerators for Chemicals.



Highly Dynamic Temperature Control Systems

The highly dynamic temperature control systems from JULABO can be used for demanding temperature applications ranging from -92 °C to +400 °C. The new PRESTO® line offers unique high performance specifications to meet these requirements.

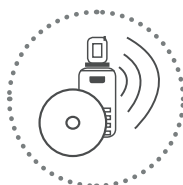

Wireless Communication & Software Solutions

JULABO facilitates the automation of applications. The temperature control units can be comfortably controlled and monitored via PC.



Recirculating Coolers

JULABO recirculating coolers are highly efficient and therefore offer an environmentally friendly and economic alternative to tap water cooling in the range of -25 °C to +130 °C.

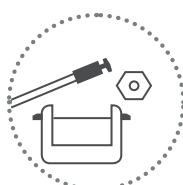

Accessories

The extensive range of accessories for all our instruments allows the flexible use of JULABO products in research and industry.

Comprehensive service and on-site support

JULABO takes pride in offering customers expert advice for pairing the proper JULABO temperature control solution to their specific application. JULABO service and support options include installation and calibration, equipment qualification documentation and application training. These invaluable services ensure customer confidence in the operation and maintenance of their JULABO unit.

Individual requirements – individual products

The wide range of JULABO offers a solution for almost any application. However, if a specific application needs more than a standard product is able to offer, the JULABO specialists will work out an individual solution with you.



JULABO. Quality.

Highest standards of quality for a long product life.



Green technology.

Deliberately engineered with environmentally friendly materials and technologies.



Satisfied customers.

11 subsidiaries and more than 100 partners worldwide guarantee fast and qualified JULABO support.



100 % checked.

100 % testing. 100 % quality. Every JULABO product is shipped to customers after successful final inspection.



Quick start.

Individual JULABO consultation and comprehensive manuals at your disposal.



Services 24/7.

Around the clock availability. You can find suitable accessories, data sheets, manuals, case studies and more at www.julabo.com.

Technical Specifications

Calibration Baths

Model	Order No.	Working temperature range °C	Display/resolution °C	Temperature control	Temperature stability °C	Heating capacity kW	Cooling of refrigeration unit	Cooling capacity (Medium)	
								+20	+10
SL-8K	9 352 508	+50 ... +300	VFD/0.01	ICC	±0.005	3	Air	-	-
SL-14K	9 352 514	+50 ... +300	VFD/0.01	ICC	±0.005	3	Air	-	-
FK-30SL	9 352 627	-30 ... +200	VFD/0.01	ICC	±0.005	2	Air	0.46	-
FK-31SL	9 352 628	-30 ... +200	VFD/0.01	ICC	±0.005	2	Air	0.46	-

Visco Baths & Beer Forcing Test Bath

Model	Order No.	Working temperature range °C	Display / resolution °C	Temperature control	Temperature stability °C	Heating capacity kW	Cooling of refrigeration unit	Cooling capacity (kW)	
								+20	+10
ME-31A	9 162 331	+20 ... +60	VFD/0.01	PID3	±0.01	2	Air	-	-
ME-16G	9 162 616	+20 ... +100	VFD/0.01	PID3	±0.01	2	Air	-	-
ME-18V	9 162 518	+20 ... +150	VFD/0.01	PID3	±0.01	2	Air	-	-
F38-ME	9 162 638	-38 ... +80	VFD/0.01	PID3	±0.05	2	Air	0.92	-

Immersion/Flow-Through Coolers

Model	Order No.	Working temperature range °C	Display / resolution °C	Temperature control	Temperature stability °C	Cooling of refrigeration unit	Cooling capacity (kW) a (Bat	
							+20	+10
FT200	9 650 820	-20 ... +30	-	-	-	Air	0.25	0.2
FT400	9 650 840	-40 ... +30	-	-	-	Air	0.45	0.36
FT900	9 650 890	-90 ... +30	-	-	-	Air	0.3	0.27
FT402	9 650 842	-40 ... +30	0.1	2-point	±0.5	Air	0.45	0.36
FT902	9 650 892	-90 ... +30	0.1	2-point	±1	Air	0.3	0.27
FT903	9 650 893	-90 ... +30	0.1	2-point	±1	Air	0.3	0.29
FD200	9 655 825	+10 ... +30	-	-	-	Air	0.22	0.18

Temperature Controllers

Model	Order No.	Working temperature range °C	Quantity/displays	Display / resolution °C	Temperature control	Temperature stability °C	Max. connected load kW
LC6	9 700 160	-100 ... +400	2/(LED, LCD)	0.01	ICC	< ±0.03	3

Refrigerators for Chemicals

Model	Order No.	Working temperature range °C	Temperature setting °C	Temperature display	Alarm signal	Temperature stability °C	Overheating protection compressor °C
KRC50	8 800 705	-2 ... +12	Analog	LED	Optical	±1	105
KRC180	8 800 718	-2 ... +12	Analog	LED	Optical	±1	105

Unless otherwise indicated, all data relates to the operation at nominal voltage and frequency and +20 °C ambient temperature. Cooling capacity measured according to DIN12876-2.

Capacity (kW) at bath temperature (°C) medium: JULABO Thermal Ethanol)				Type ⊖ Circulation pump	Pump		Bath opening/ depth	Filling volume liters	Bath cover	Classification according to DIN 12876-1
0	-20	-40	-80		Pressure bar	Flow rate l/min				
-	-	-	-	⊖	0.4 ... 0.7	22 ... 26	Ø 12/17	8	Integrated	III (FL)
-	-	-	-	⊖	0.4 ... 0.7	22 ... 26	Ø 12/31	14	Integrated	III (FL)
0.34	0.15	-	-	⊖	0.4 ... 0.7	22 ... 26	Ø 12/17	14	Integrated	III (FL)
0.34	0.15	-	-	⊖	0.4 ... 0.7	22 ... 26	Ø 12/31	24	Integrated	III (FL)

Capacity (V) at bath temperature (°C) (Bath fluid: Ethanol)				Type ⊖ Circulation pump	Pump		Bath opening/ quantity/depth	Filling volume liters	Bath cover	Classification according to DIN 12876-1
0	-20	-40	-80		Pressure bar	Flow rate l/min				
-	-	-	-	⊖	0.23 ... 0.45	11 ... 16	9×9/3x/37	31	Integrated	III (FL)
-	-	-	-	⊖	0.23 ... 0.45	11 ... 16	7.6×7.6/2x/31	16	Integrated	III (FL)
-	-	-	-	⊖	0.23 ... 0.45	11 ... 16	9×9/2x/37	18	Integrated	III (FL)
0.66	0.32	-	-	⊖	0.23 ... 0.45	11 ... 16	35×41/27	45	Integrated	III (FL)

Capacity at bath temperature (°C) Bath fluid: Ethanol)				Barbed fittings inner dia.	Immersion probe/flexible corrugated tubing (L × Ø)	Connection tube (L)	IP class according to IEC 60529
0	-20	-40	-80				
0.15	0.04	-	-	-	9×4	120	IP21
0.30	0.14	0.03	-	-	12×5	120	IP21
0.27	0.24	0.2	0.07	-	65×1.5 flexible	160	IP21
0.30	0.14	0.03	-	-	12×5	120	IP21
0.27	0.24	0.2	0.07	-	65×1.5 flexible	160	IP21
0.28	0.25	0.23	0.05	-	5.6×14.0	160	IP21
-	-	-	-	8/12 mm	-	-	IP21

Working sensor	Safety sensor	IP class according to IEC 60529	Power requirement V/Hz/A	RS232 connection	Permissible ambient temperature °C	Dimensions W×L×H cm cm	Weight net kg	Model
1 Pt100	1 Pt100	IP31	230/50-60/10	yes	5 ... 40	17×17×16	3	LC4
2 Pt100	1 Pt100	IP31	230/50-60/14	yes	5 ... 40	21×18×18	4	LC6

Working sensor	Safety sensor	Volumetric capacity liters	Power requirement V/Hz/A	Inner dimensions W×L×H cm cm	Outer dimensions W×L×H cm cm	Weight net kg	Model
PTC	PTC	68	230/50/1	42×29×44	55×64×63	32	KRC50
PTC	PTC	180	230/50/1	52×40×70	60×64×86	35	KRC180

IP class according to IEC 60529	Power requirement	RS232 interface	Permissible ambient temperature	Dimensions W × L × H cm	Weight net	Model
	V/Hz/A					
IP21	230/50-60/13	yes	5 ... 40	22 × 46 × 47	16	SL-8K
IP21	230/50-60/13	yes	5 ... 40	22 × 46 × 61	20	SL-14K
IP21	230/50/16	yes	5 ... 40	32 × 45 × 79	48	FK-30SL
IP21	230/50/16	yes	5 ... 40	32 × 45 × 91	51	FK-31SL

IP class according to IEC 60529	Power requirement	RS232 interface	Permissible ambient temperature	Dimensions W × L × H cm	Weight net	Model
	V/Hz/A					
IP21	230/50-60/9	yes	5 ... 40	50 × 20 × 56	11	ME-31A
IP21	230/50-60/9	yes	5 ... 40	∅ 29 × 48	9	ME-16G
IP21	230/50-60/9	yes	5 ... 40	36 × 24 × 54	17	ME-18V
IP21	230/50/13	yes	5 ... 40	46 × 70 × 89	72	F38-ME

Power requirement	RS232 interface	Permissible ambient temperature	Dimensions W × L × H cm	Weight net	Model
V/Hz/A					
230/50/2	no	5 ... 40	18 × 27 × 39	18	FT200
230/50/4	no	5 ... 35	20 × 30 × 43	24	FT400
230/50-60/5	no	5 ... 35	38 × 55 × 60	50	FT900
230/50/4	no	5 ... 35	20 × 30 × 43	24	FT402
230/50-60/5	no	5 ... 35	38 × 55 × 60	50	FT902
230/50-60	no	5 ... 40	38 × 55 × 60	50	FT903
230/50/2	no	5 ... 35	18 × 27 × 39	16	FD200

Unless otherwise indicated, all data relates to the operation at nominal voltage and frequency and +20 °C ambient temperature. Cooling capacity measured according to DIN12876-2.

Voltage Options

Model	Rated voltage (V)	Frequency (Hz)	Voltage range (V)													Heating capacity at rated voltage (kW)								
			100	120	140	160	180	200	220	240	260													
One-phase systems																								
SL-8K	208-230	50/60														2.4 - 3								
SL-14K	208-230	50/60														2.4 - 3								
FK-30SL	208-230	50/60														1.6 - 2								
	100-115	50/60														0.8 - 1								
FK-31SL	208-230	50/60														1.6 - 2								
	100-115	50/60														0.8 - 1								
ME-31A	208-230	50/60														1.6 - 2								
	100-115	50/60														0.8 - 1								
ME-16G	208-230	50/60														1.6 - 2								
	100-115	50/60														0.8 - 1								
ME-18V	208-230	50/60														1.6 - 2								
	100-115	50/60														0.8 - 1								
F38-ME	208-230	50/60														1.6 - 2								
FT200	230	50														0								
	115	60														0								
FT400	230	50														0								
	115	60														0								
FT900	230	50														0								
	115	60														0								
FT402	230	50														0								
	115	60														0								
FT902	230	50/60														0								
	115	60														0								
FT903	230	50/60														0								
FD200	230	50														0								
	115	60														0								
LC4	230	50/60														0 ¹⁾								
	115	60														0 ¹⁾								
LC6	230	50/60														0 ²⁾								
	115	60														0 ²⁾								
KRC50	220-240	50														0								
KRC180	207-253	50														0								

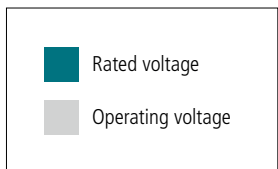

¹⁾ maximum connected load 2 kW ²⁾ maximum connected load 3 kW



GERMAN Headquarters

JULABO GmbH

Gerhard-Juchheim-Strasse 1
77960 Seelbach
Germany

Tel. +49 (0) 7823 51-0
Fax +49 (0) 7823 24 91
info.de@julabo.com
www.julabo.com

ITALY

JULABO Italia SRL
www.julabo.com

UK

JULABO UK, Ltd.
www.julabo.com

FRANCE

JULABO France SAS
www.julabo.com

NETHERLANDS

JULABO Nederland B.V.
www.julabo.com

NORTH AMERICA

JULABO USA, Inc.
www.julabo.us

JAPAN

JULABO Japan Co., Ltd.
www.julabo-japan.co.jp

KOREA

JULABO Korea Co., Ltd.
www.julabo-korea.co.kr

CHINA

JULABO Technology (Beijing) Co., Ltd.
www.julabo.com.cn

LATIN AMERICA

JULABO Latin America
www.julabo-latinamerica.com

SINGAPORE

JULABO Singapore Pte., Ltd.
www.julabo.com

INDIA

JULABO India
www.julabo.com

**Plus more than
100 partner distributors
worldwide**